

Features:

- 1. Compact Dimensions: 220×90×40
- 2. Material: Aluminum
- 3. Display options: 5 digital LCD
- 4. Capacity/Division

Table 1

CAPACITY	DIVISION1	DIVISION2	DIVISION3
200kg	0.05kg	0.1kg	0.2kg

- 5. Power: Rechargeable battery 6×AA / AC adapter 9V 500mA
- 6. Power saving (auto shut-off timing selectable: 120seconds/180seconds/240seconds/360seconds/Off)
- 7. Operating Temperature: 5~35°C
- 8. Operating Humidity: 25%~95%RH
- 9. 4Keys: HOLD/BMI , UNIT/WEIGHT , ZERO , TARE







- HOLD/BMI** Press this key to store weight value
- UNIT/WEIGHT** Toggle among KG and LB unit
- ZERO** Zero the weight
- TARE** Tare the weight

- 11. Zero Range (4% to full capacity)
- 12. Tare Range (100% to full capacity)
- 13. Error Message indication:

- EEEE** Ovrload
- ErrL** Power on zero count too low
- ErrH** Power on zero count too high
- ErrE** Eeprom Error
-  Low battery indication

- 14. Two calibration weight units : kg / lb
- 15. Open calibration weight
- 16. Power on zero-setting range: $\pm 10\%$
- 17. Zero range: $\pm 4\%$ of full capacity
- 18. Three modes : Normal mode / Setting mode /Internal Auto Calibration mode
- 19. RS232 function

Auto shut off mode

STATE	DESCRIPTION	Time for shut off	NOTE
	Low battery indication	30 seconds	
	EEPROM ERROR	30 seconds	
	Overload	30 seconds	
	Zero value higher	30 seconds	
	Zero value lower	30 seconds	
	Zero tracking	According as time of shut off	
Minus weight value	Display of weighing is minus value	According as time of shut off	
Same weight value	Display of weighing is Same weight value	According as time of shut off	Inclusion zero tracking and minus weight
Differ weight value	Display of weighing is Different weight value	No Off	Inclusion minus weight

KEY DESCRIPTIONS:

<u>HOLD</u> <u>BMI</u>	<u>UNIT</u> <u>WEIGHT</u>	ZERO	TARE
-----------------------------------	--------------------------------------	-------------	-------------

1. HOLD/BMI:

- A. Press this key to store weight value.
- B. To release Hold feature, Press the HOLD key again.
- C. To release Hold feature and tare the weight, Press the TARE key.
- D. Press and hold this key, the scale will enter to BMI setting.

2. UNIT/WEIGHT:

- A. Select weigh units: kg or LB .
- B. The next time of powering-on will be showed the last using weighing units.

3. ZERO:

- A. When there's load on the scale , press this key to return to zero.
- B. Put a container on the scale, press this key to tare the weight, and the tarred value is stored.

4. TARE:

- A. When there's load on the scale , press this key to return to zero.
- B. Put a container on the scale, press this key to tare the weight, and the tarred value is stored.

5. POWER SWITCH:

when the scale is used or not used ,please turn the power on or the power off.

Function table:

Press and hold [**HOLD/BMI**], turn on the power switch on the right side of indicator, and then press continuously [**UNIT/WEIGHT**] three times, the display will show the “**SET**”.

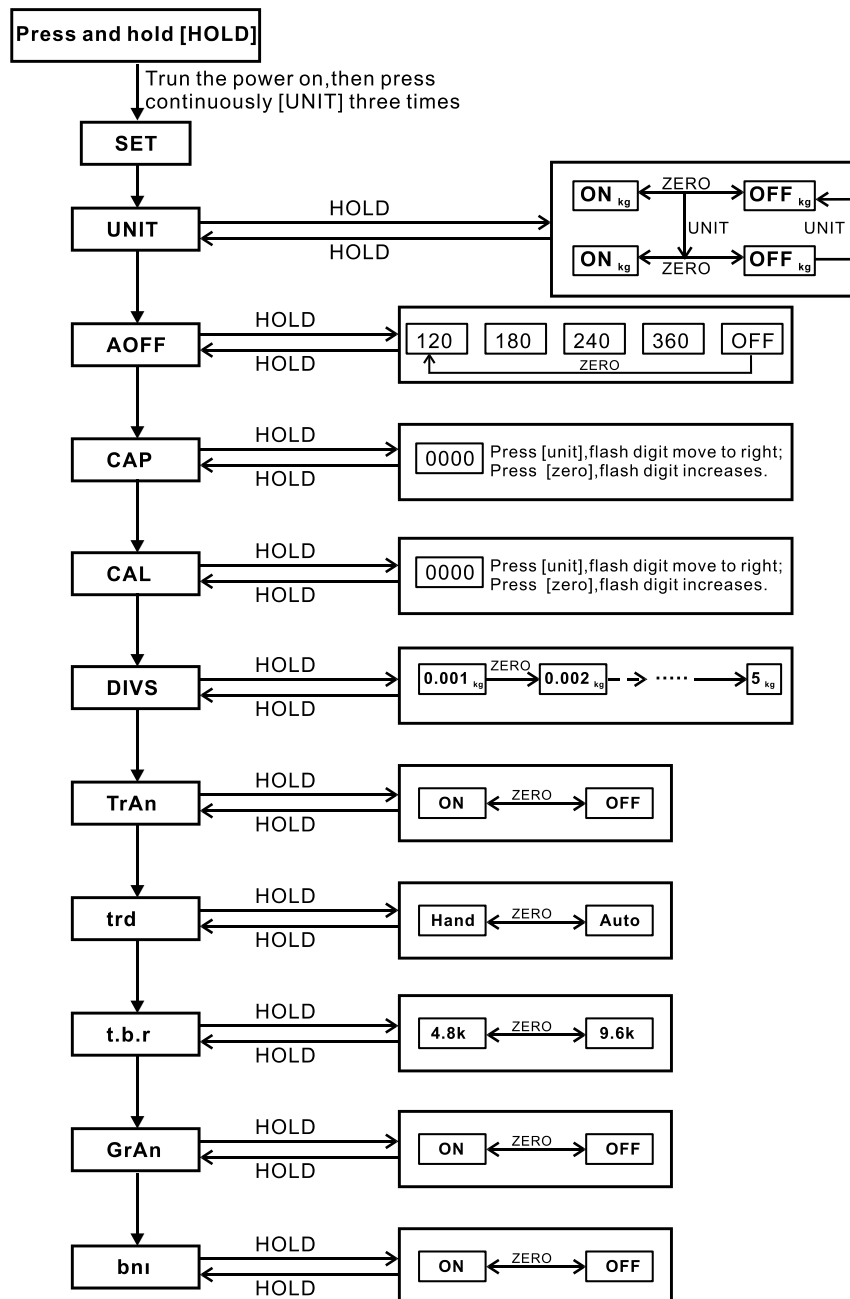

THE MEANING OF FUNCTION SETTING

1. **AOFF**: Time for auto off (120s / 180s / 240s /360s / off)
2. **Unit**: Weight units (kg / lb)
3. **CAP**: Capacity (1 ~ 9999kg)
4. **divS**: Division (0.001 ~ 5kg)
5. **CAL**: Calibration weight (1 ~ 9999kg)
6. **trAn**: RS232 Transfer
7. **t.b.r.**: RS232 Transfer band rate
8. **Grav.**: Gravity
9. **trd.**: Transfer mode
10. **BMI**: WEIGHT/H² (ON/OFF)

Table2—Calibration Weight

1. Press and hold **[ZERO]** to turn the power on, and then press continuously **[UNIT/WEIGHT]** three times, the display will show the “CALukg”.(press **[UNIT/WEIGHT]** key to selected the calibration unit)
2. Press **[ZERO]** key, when the display will show AD value, press **[ZERO]** key, the display will show “SAVE” and then show calibration weight.
3. Press **[ZERO]** key again, the display will show “SAVE” and then return to AD value. Now calibration weight is complete.

BMI function setting

1. Body on the pan, it should your weight: 80kg
2. When the display stable, press HOLD to keep the display 80kg
3. Press and hold the HOLD key, until it display HLT 100, it means to input your height in cm
4. Press HOLD and UNIT keys until the display 180, it means 180cm
5. Press TARE, it display 80kg and 25%.

RS232 TRANSMIT FUNCTION

1. When the function **[trAn]** set **[ON]**, The RS232 is activated
2. Baud rate is selected 4800 or 9600 when the function **[t.b.r.]** set 4800 or 9600 .
3. **RS232 Transmission Agreement:**
 - Mode: Simplex Asynchronous Serial
 - Baud rate: 4800 or 9600
 - Data Bit: 8
 - Parity Bit: NONE
 - Stop Bit: 1
 - Data Format: ASCII
4. **Transmission Information Format: 16 Byte , blank=20H**
`<STX><Status><+/-><D><D><D><D><D><D><U><U><U><U><ETX>`
5. **Transmission Information Format show:**
 - STX: Start of Transmission=02H
 - Status: Status bit
 - Example: *(2AH)=Stable weight, ~(7EH)=Unstable Weight
 - +/-: +=(2BH)=Positive Weight , -=(2Dh)=Negat Weight
 - DDDDDDD: Value of Weight , 7 ASCII Code
 - UUUUU: 4 ASCII Code Weight Units: kg or LB
 - ETX: Stop of Transmission =03H

SETTING THE ACCELERATION TO GRAVITY MODE

1. Press **[TARE]** and **[UNITS]** first, then press **[ON/OFF]**, while keeping **[TARE]** and **[UNITS]**pressed, the display will show “SEt”, then press the **[UNITS]** several times until the display show ”GrAv” press **[TARE]** the display show “on” press the **[HOLD]** the display show “OFF” .When the display show “ON” means acceleration to gravity is activated. When the display show “OFF” means acceleration to gravity is inactivated.
2. When acceleration to gravity is activated press **[ON/OFF]** turn the power off, then press **[ON/OFF]** turn the power on, then press **[UNITS]** key 3 seconds enter to acceleration to gravity mode .1). when the display show “C9.○ 00” (○ for flash digit) first setting the local gravity.2). press **[TARE]** key again, rightward flash digit, 3).press **[HOLD]** key, increase digit input the gravity value, press **[UNITS]** the display enter to another local acceleration to gravity mode.
3. When the display show “U9.○ 00” (○ for flash digit) repeat the steps 1)-3) .press **[UNITS]** the display will return the normal weighing mode.

**HANGZHOU
TIANHENG**

Product Description
MS3200 indicator

Page: 7 of 7

Product Type: MS3200

interface:

1: signal interface: (microphone socket)

Pin 1 (red) -----→E+ (positive source)

Pin 2 (blue) -----→S+ (positive signal)

Pin 3 (black) -----→E- (negative source)

Pin 4 (white)-----→S- (negative signal)

Pin 5 (no)

no sign -----→GND

2: Rechargeable battery socket:

AC/DC 9V-----inner positive ,external negative

3: RS232 interface: DB9

Prepared by: Lin

Data: 2007-01

Version: V3.3